

RING AC 2S CE

Acrylic

Sıva Üstü/ Surface Mounted



RING AC 2S SU

Acrylic

Sarkıt / Suspended

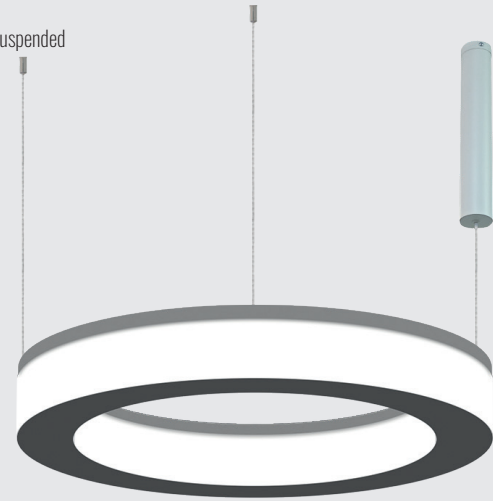

RING AC 3S CE

Acrylic

Sıva Üstü/ Surface Mounted



RING AC 3S SU

Acrylic

Sarkıt / Suspended

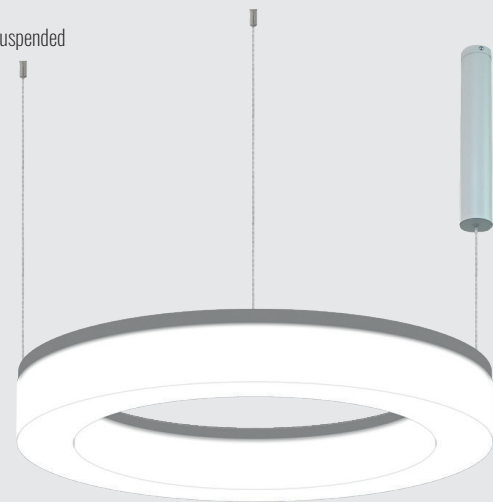

Özellikler Specifications

Ana Gövde	Elektrostatik toz boyalı metal gövde
<i>Chassis</i>	<i>Aluminium body with electrostatic powder coated</i>
Difüzör	PMMA Akrilik difüzör (opal 80% - 60%) ve yapışkan folyo
<i>Diffuser</i>	<i>PMMA Acrylic diffuser (opal 80% - 60%) and adhesive film</i>
LED & Trafo	Samsung, Osram, Tridonic, Philips, MeanWell, Eaglerise vb.
<i>LED & Driver</i>	<i>Samsung, Osram, Tridonic, Philips, MeanWell, Eaglerise etc.</i>
Opsiyon	Akıllı sistemler (DALI-DIM) ve acil kit
<i>Option</i>	<i>Intelligent systems (DALI-DIM) and emergency kits</i>

Gövde Renkeri Chasis Colors



Işık Renkeri Light Colors

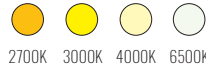

Işık Açısı Light Beam

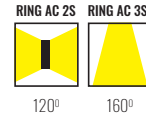

Montaj Mounting

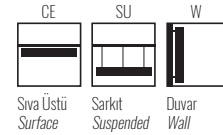

Difüzörler Diffusers

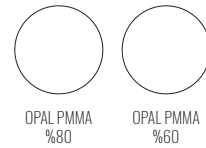

Ölçüler Dimensions

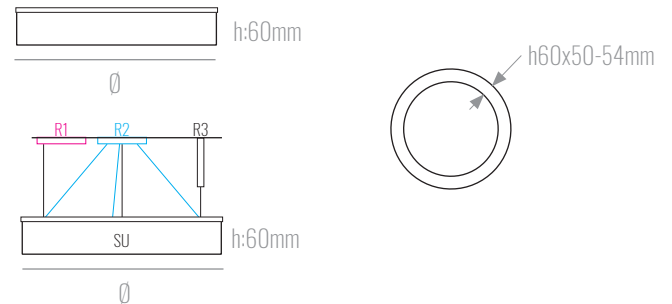

RING 2S

2700K-3000K-4000K-6500K, 220-240VAC-50/60Hz., MacAdam 3, CRI>80

Çap (Ø) Diameter (Ø) mm	Güç Power (W)	Işık Gücü Lumen (lm) (opal 80%)	Verimlilik Efficiency (lm/W) (opal 80%)	Işık Gücü Lumen (lm) (opal 60%)	Verimlilik Efficiency (lm/W) (opal 60%)
400	30	3000	100	2400	80
600	50	5000	100	4000	80
900	75	7500	100	6000	80
1200	100	10000	100	8000	80
1500	125	12500	100	10000	80
2000	165	16500	100	13200	80

Lümen değerleri 4000K ışık sıcaklığı için verilmiştir. Teknik değerler, LED ve ekipmanların gelişimine bağlı olarak değişebilir. Lumen values are given for 4000K light temperature. Technical values may change depending on the development of LED and equipment.

RING 3S

2700K-3000K-4000K-6500K, 220-240VAC-50/60Hz., MacAdam 3, CRI>80

Çap (Ø) Diameter (Ø) mm	Güç Power (W)	Işık Gücü Lumen (lm) (opal 80%)	Verimlilik Efficiency (lm/W) (opal 80%)	Işık Gücü Lumen (lm) (opal 60%)	Verimlilik Efficiency (lm/W) (opal 60%)
400	30	3300	110	2700	90
600	50	5500	110	4500	90
900	75	8250	110	6750	90
1200	100	11000	110	9000	90
1500	125	13750	110	11250	90
2000	165	18150	110	14850	90

Lümen değerleri 4000K ışık sıcaklığı için verilmiştir. Teknik değerler, LED ve ekipmanların gelişimine bağlı olarak değişebilir. Lumen values are given for 4000K light temperature. Technical values may change depending on the development of LED and equipment.

